















**Ablaufgarnitur mit Zugknopf für Standmontage 1 1/4" - Champagne gebürstet
(22kt Gold)**

IMO

10 200 970



Passt zu: IMO, LULU, MADISON, MEM,
TARA, CL.1, LISSÉ, VAIA, META, CYO

	Champagne gebürstet (22kt Gold)	10 200 970-46
	Chrom	10 200 970-00
	Platin gebürstet	10 200 970-06
	Platin	10 200 970-08
	Messing (23kt Gold)	10 200 970-09
	Dark Chrome	10 200 970-19
	Light Gold	10 200 970-26
	Light Gold gebürstet	10 200 970-27
	Messing gebürstet (23kt Gold)	10 200 970-28
	Schwarz matt	10 200 970-33
	Bronze gebürstet	10 200 970-42
	Champagne (22kt Gold)	10 200 970-47
	Chrom gebürstet	10 200 970-93
	Dark Platinum gebürstet	10 200 970-99



Ablaufgarnitur mit Zugknopf für Standmontage 1 1/4" - Champagne gebürstet
(22kt Gold)

IMO

10 200 970

Nur für Becken mit Überlauf geeignet.

Ablaufgarnitur mit Zugknopf für Standmontage 1 1/4" - Champagne gebürstet
(22kt Gold)

IMO

10 200 970

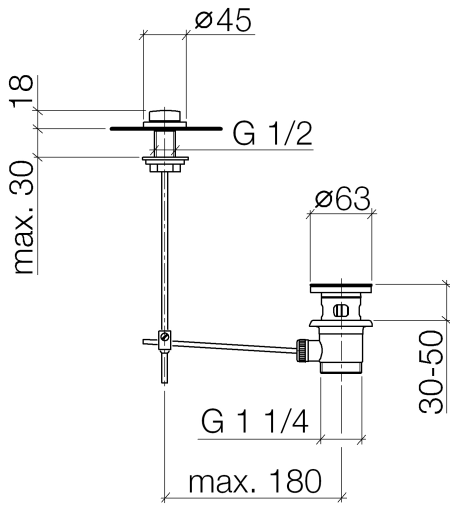

10 200 970

Ersatzteile für die
anderen
Oberflächenvarianten
finden Sie hier:
Chrom



Ersatzteilstückliste

Nr.	Artikelnummer	Benennung	Verbaumenge	Lieferzeit
1	09 21 33 001-46	Griff	1	30
2	09 14 10 007 90	Dichtung	2	2
3	09 31 09 004-46	Zugstange	1	30
4	09 18 40 022-46	Huelse	1	30
5	09 14 10 095 90	Dichtung	1	2
6	09 14 05 012 90	Dichtung	1	2
7	09 14 40 001 90	Dichtung	1	60
8	09 23 10 010 90	Mutter	1	2
9	90 11 01 001 00-46	Ablaufgarnitur	1	30